

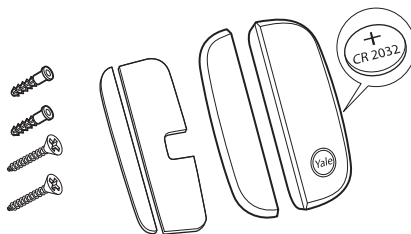

Product Code: **AC-DC**



(GB) Please see your Yale Sync Smart Home Alarm system Instruction manual for the following: Adding this component to your Alarm, Installing, Changing the batteries, Troubleshooting. To download the manual please visit the product page at www.yalelock.com/smart-living

(DE) In der Bedienungsanleitung Deines Yale Sync Smart Home Alarms findest Du weitere Informationen zu: Einbinden dieses Zubehörs in Dein Alarmsystem, Einlegen und Wechseln der Batterien und Fehlersuche. Das Handbuch kannst Du herunterladen auf www.yalelock.com/smart-living

(FR) Veuillez consulter le mode d'emploi de votre système d'alarme Yale Sync pour les opérations suivantes : ajout d'un nouvel appareil, installation, remplacement des piles, dépannage. Pour télécharger le manuel d'utilisation complet, visitez www.yalelock.com/smart-living

(IT) Si prega di consultare il manuale istruzioni dell'allarme Yale Sync Smart Home per le seguenti operazioni: Aggiungere questo componente al vostro Allarme, Installazione, Sostituzione batterie, Risoluzione dei problemi. Per scaricare il manuale visita la pagina prodotto www.yalelock.com/smart-living

(ES) Por favor, consultar el manual de instrucciones de Yale Sync Smart Home Alarm para lo siguiente: Añadir este dispositivo a tu alarma, instalación, cambio de pilas y preguntas frecuentes. Para la descarga del manual puedes visitar www.yalelock.com/smart-living

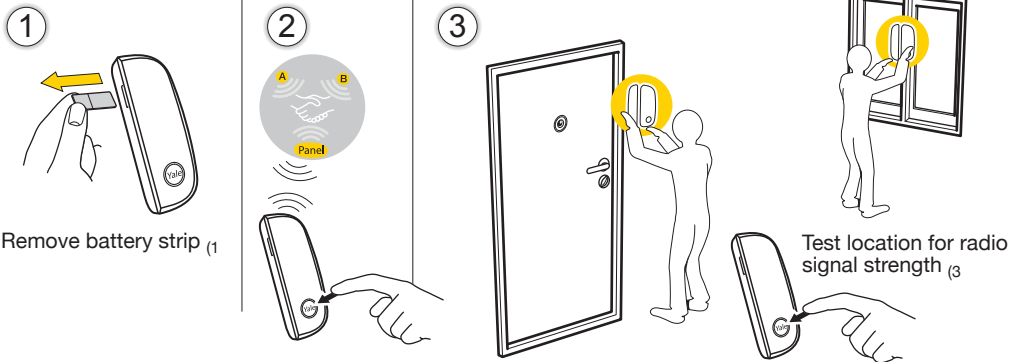

(1) (DE) Entfernen der Batteriefolie - (FR) Retirez la languette de protection des piles - (IT) Rimuovi la linguetta della batteria - (ES) Retira la tira de la batería

(2) (DE) Verbinden - (FR) Apparez - (IT) Associazione - (ES) Vincular.

(3) (DE) Teste die Signalstärke am geplanten Standort - (FR) Testez la portée du signal dans les emplacements envisagés - (IT) Verifica la potenza del segnale nella posizione prescelta - (ES) Comprueba la ubicación para una correcta señal de radio.



①

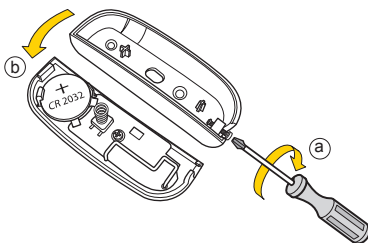
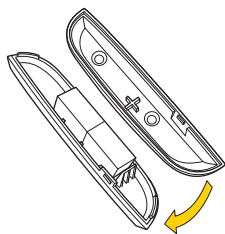

② a

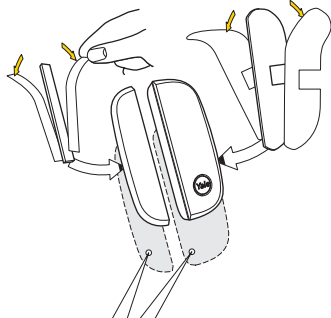

② b

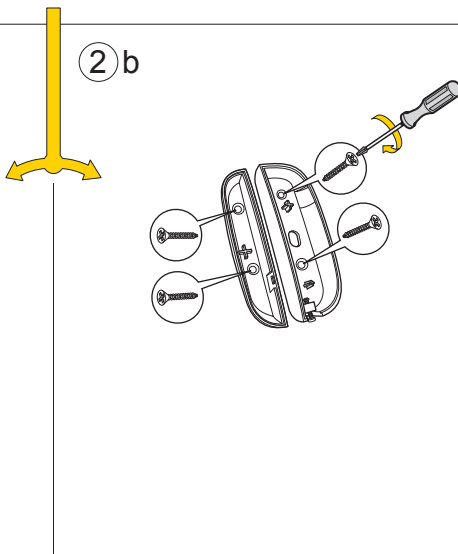

i



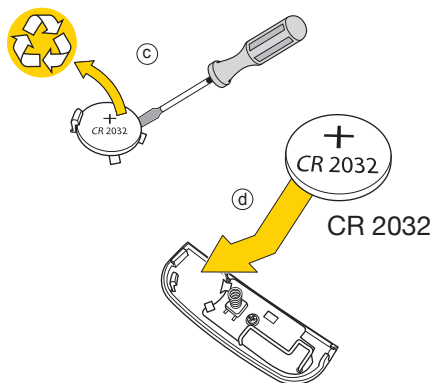
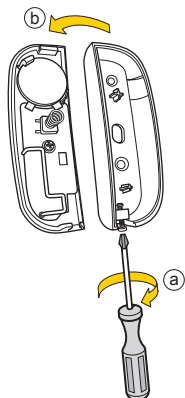
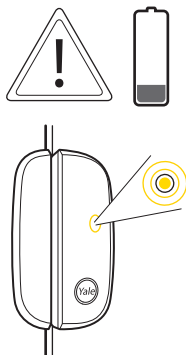

i

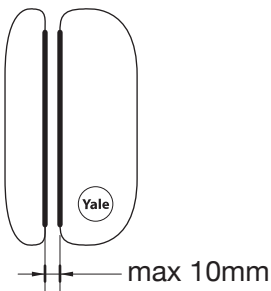
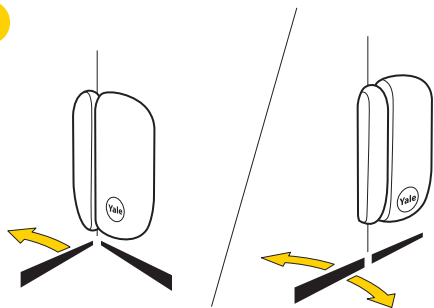

(GB) Environment - (DE) Umgebung - (FR) Environnement - (IT) Ambiente - (ES) Ambiente.

Specification



Housings ABS/polycarbonate
Radio: 868 MHz FM
RF Transmission: 18mA

-10°C to 50°C



85%



relative humidity
non-condensing

Product	Frequency / Band	EIRP [dBm]
AC-DC	F1-868-2W	1.98±3dB

(DE) Alle Geräte , Gehäuse ABS Polycarbonat.
(FR) Tous les dispositifs. Caissons ABS / polycarbonate.
(IT) Involucro di TUTTI i dispositivi ABS/polycarbonato.
(ES) Todos los dispositivos. Carcasas de ABS / polycarbonato.





www.yalelock.com/smart-living

(GB) Hereby, ASSA ABLOY Ltd., School Street, Willenhall, West Midlands, England WV13 3PW declares that the radio equipment type AC-DC is in compliance with Directive 2014/53/EU. The full text of the EU declaration of conformity is available at the following internet address:

www.yalelock.com/smart-living/doc

(DE) Hiermit erklärt ASSA ABLOY Ltd., School Street, Willenhall, West Midlands, England WV13 3PW, dass der Funkanlagentyp AC-DC der Richtlinie 2014/53/EU entspricht. Der vollständige Text der EU-Konformitätserklärung ist unter der folgenden Internetadresse verfügbar:

www.yalelock.com/smart-living/doc

(FR) Le soussigné, ASSA ABLOY Ltd., School Street, Willenhall, West Midlands, England WV13 3PW, déclare que l'équipement radioélectrique du type AC-DC est conforme à la directive 2014/53/UE. Le texte complet de la déclaration UE de conformité est disponible à l'adresse internet suivante: www.yalelock.com/smart-living/doc ••• Message à destination des professionnels ••• Si vous souhaitez installer Smart Home/ phone Alarm dans votre société, vous devez obligatoirement demander une autorisation à la Commission Nationale de l'Informatique et des Libertés.

(IT) Il produttore, ASSA ABLOY Ltd., School Street, Willenhall, West Midlands, England WV13 3PW, dichiara che il tipo di apparecchiatura radio AC-DC è conforme alla direttiva 2014/53/UE. Il testo completo della dichiarazione di conformità UE è disponibile al seguente indirizzo Internet:

22.5.2014 L 153/104 Gazzetta ufficiale dell'Unione europea IT: www.yalelock.com/smart-living/doc

(ES) Por la presente, ASSA ABLOY Ltd., School Street, Willenhall, West Midlands, England WV13 3PW declara que el tipo de equipo radioeléctrico AC-DC es conforme con la Directiva 2014/53/UE. El texto completo de la declaración UE de conformidad está disponible en la dirección Internet siguiente: www.yalelock.com/smart-living/doc



THE YALE BRAND, with its unparalleled global reach and range of products, reassures more people in more countries than any other consumer locking solution.

THE ASSA ABLOY GROUP is the world's leading manufacturer and supplier of locking solutions, dedicated to satisfying end-user needs for security, safety and convenience.